

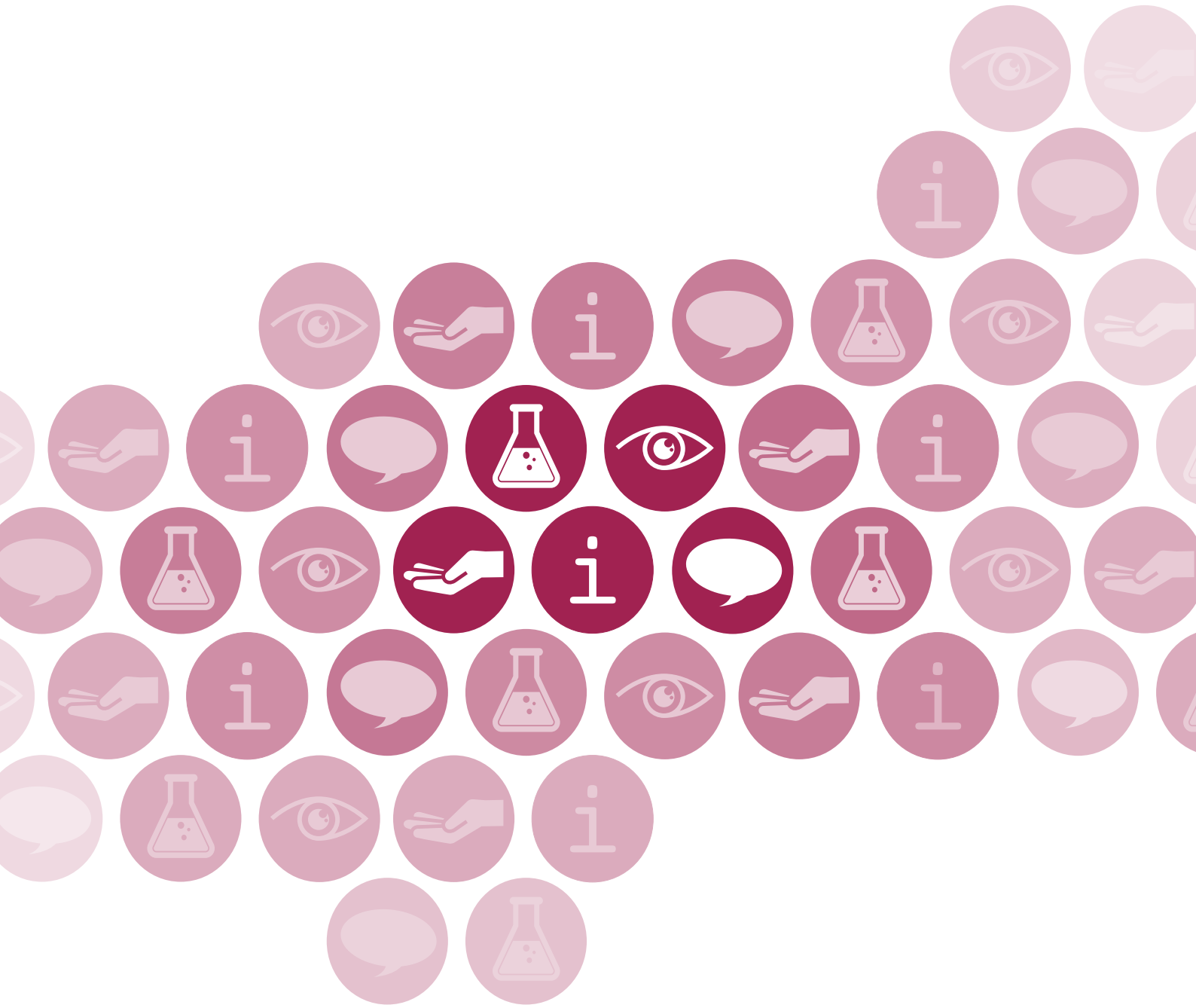

The Royal College of Pathologists
Pathology: the science behind the cure



**CHOOSE YOUR OWN
PATHOLOGY ADVENTURE**

Introduction

This resource has been developed with the current COVID-19 pandemic in mind. As pathologists might not be able to visit schools right now, and teachers may be looking for new, easily accessible activities that can be run in the classroom (or at home), the Royal College of Pathologists (RCPATH) has come up with: *Choose Your Own Pathology Adventure*.

Follow the flowchart based on whatever materials you have available and then find the corresponding activity in this pack. Each activity is linked to a pathology specialty and is suitable for individuals or small student groups. Ideally, these should be run alongside an online video chat or a demonstration by a pathologist. [Contact](#) the RCPATH Public Engagement team to find out about upcoming events and how to arrange a 'virtual visit' from a pathologist.



Choose your own pathology adventure/activity ... (based on what you have)

Yes 
No 

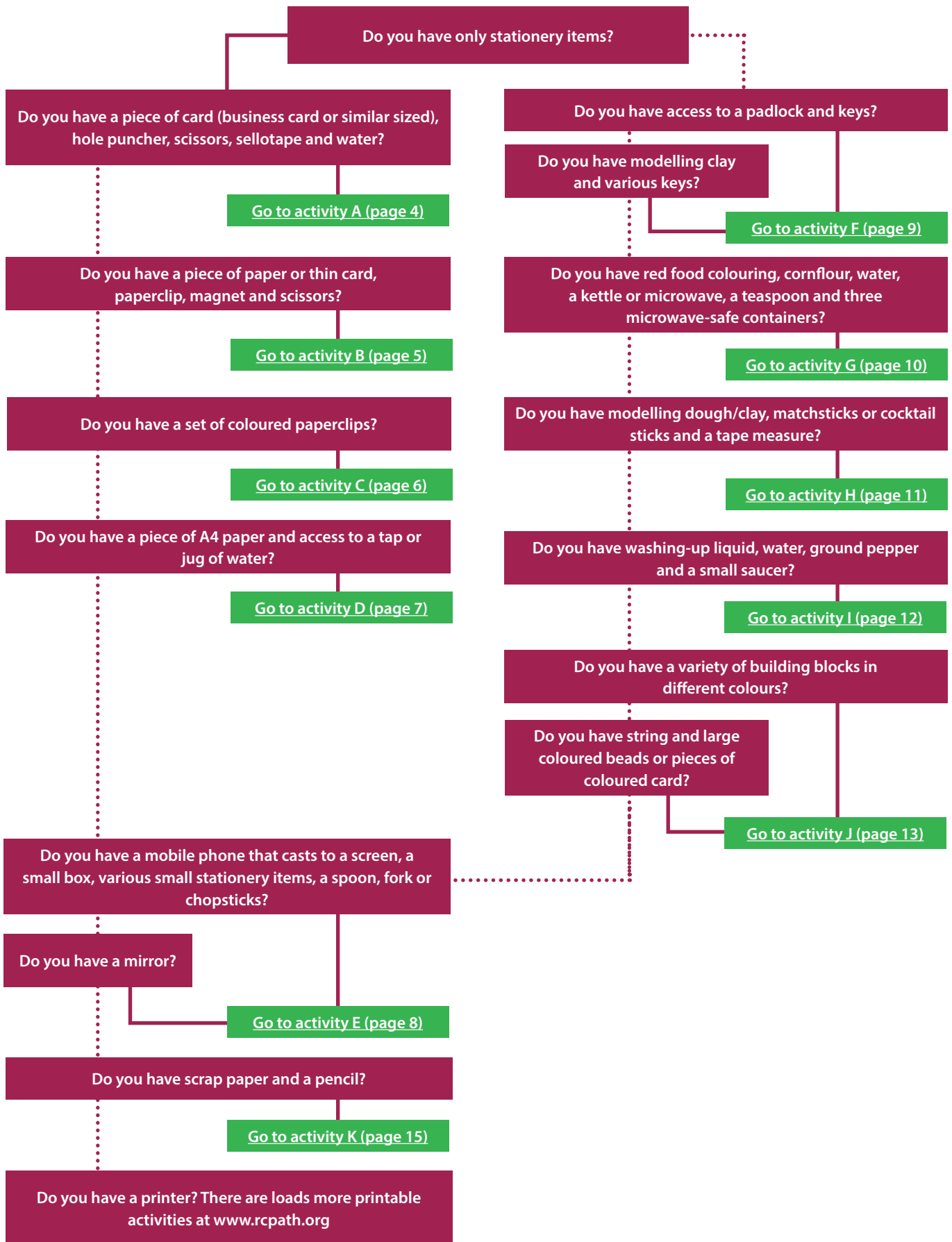

A: Scoping with business cards

Specialty: Cellular pathology, Microbiology and Virology

Find out more about these specialties here:

1. [Histopathology/cellular pathology careers page](#)
2. [Medical microbiology careers page](#)
3. [Virology careers page](#)

Use an old business card to make a microscope, following the template here. Punch a hole using the hole-puncher, then cut along the bold lines and fold along the dotted lines. Stick a small piece of clear sticky tape over the hole and fold the card to make a small platform. Add a droplet of water on top of the tape to create your microscope lens. Place small items (e.g. leaf, insect, piece of newspaper) under the 'lens platform' in order to magnify it and see the detail.

Pathologists can look at tissue samples under the microscope to magnify cells and find any abnormalities. Microbiologists can look at fluids and blood and spot microorganisms. Anything that looks different can hold clues as to what the patient might be suffering from, and what the treatment needs to be.

The drop magnifies small items up to 50 times, working like a convex lens. When we look at an object, light travels in parallel rays, bouncing off the object into our eyes, where an upside down image of it appears on the back of our eye (retina), and our brain makes sense of what it is, flipping it the right way up. A convex lens is rugby-ball shaped and bends (refracts) the light rays, bringing them together to a point. This reaches our eyes and creates an image on the retina, which makes it seem as if the object is bigger than it actually is.

Standard business card 85 mm x 55 mm

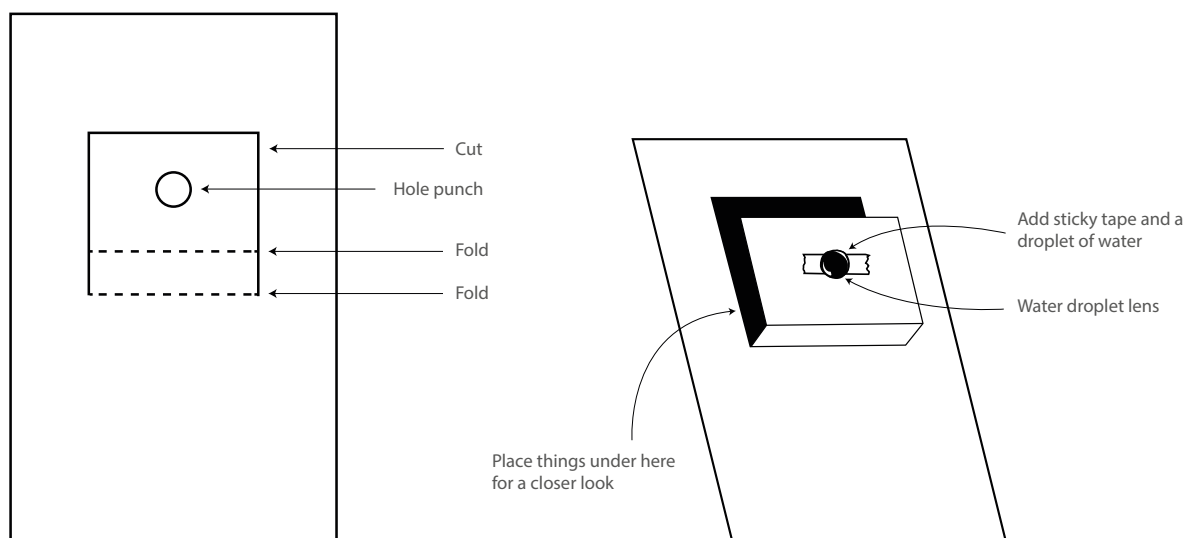

B: Everybody's antibodies

Specialty: Immunology, Virology

Find out more about these specialties here:

1. [Virology careers page](#)
1. [Immunology careers page](#)

Cut a capital 'Y' shape out of paper or thin card. This is your antibody. Clip a paperclip to each arm of the antibody. Spread out various items on your desk, e.g. stationery, beads, shells or pebbles, and then add some magnets. Take your antibody and move it gently across the items. What is it attracted to?

Many of us have heard about 'having antibodies' but what are they? An antibody is a Y-shaped protein produced by our immune system in response to something foreign in our bodies, such as bacteria or viruses (pathogens). Antibodies recognise specific features of the bacteria or viruses, which are called antigens, and bind to them. The paperclips represent the antigen-binding sites on the antibody, which are specific to the antigen (magnets). Once bound, the antibodies signal to other immune system elements to attack the pathogen.

Antibodies can remain in your circulation as part of your immune system's memory, even years after an infection, depending on the illness. This makes them useful for testing whether someone has previously had a particular infection or has some immunity to a pathogen. Antibodies can also be used to test if someone has managed to make a response to a vaccine, which is when a person is given an inactivated pathogen, or part of a pathogen, to 'teach' the immune system to recognise that pathogen and protect the person from the disease.

See Activity J, too, about blood group antigens and antibodies, and Activity F about lock and key matching, which shows how antibodies and antigens work.

Clip paperclips onto the end of the paper 'Y'

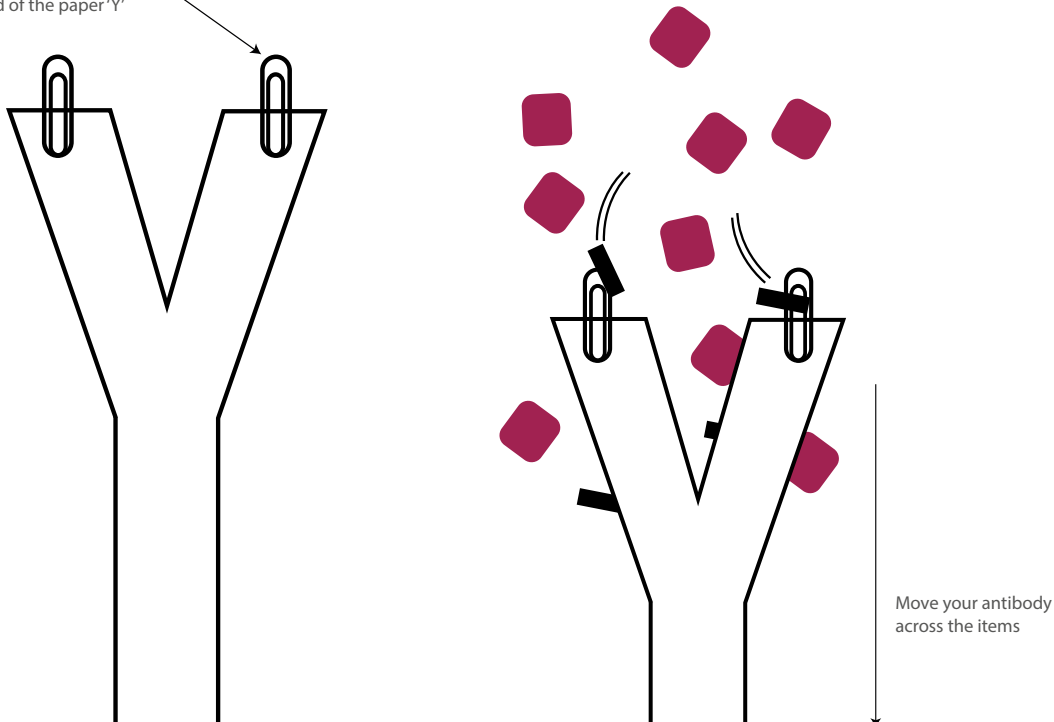

C: Chain letters

Specialty: Genetics, Reproductive science

Find out more about these specialties here:

1. [Genetics careers page](#)
2. [Reproductive science careers page](#)

The variety of life we see all around us is because of DNA (deoxyribonucleic acid), a molecule found in the nucleus of each of our cells. Sequences of DNA code for each amino acid, the building blocks of proteins.

There are two important processes when sections of DNA code for proteins: transcription and translation. First, DNA is transcribed into mRNA (messenger RNA) in the cell nucleus. Second, these mRNA sequences are then translated into an amino acid sequence, forming the protein. This happens in the cell cytoplasm.

The mRNA sequence is made up of the letters: A, C, G and U. These are the nucleotide bases: adenine, cytosine, guanine and uracil. (DNA contains T for thymine instead of U.)

Take some coloured paperclips (you only need four colours), and give each nucleotide base a colour, e.g. A: yellow, C: pink, G: silver, U: purple.

Look at the amino acid table below. Find the triplet base code, GUC. This is the mRNA code for the amino acid Valine, or V. To make this, you would link paperclips in this order: silver-purple-pink.

Using this table, and your paperclips, can you string together some mRNA that will spell out a word in amino acid letters?

		Second base					
		U	C	A	G		
First base	U	UUU } Phenylalanine F UUC } UUA } Leucine L UUG }	UCU } Serine S UCC } UCA } UCG }	UAU } Tyrosine Y UAC } UAA } Stop codon UAG } Stop codon	UGU } Cysteine C UGC } UGA } Stop codon UGG } Tryptophan W	Third base	U
	C	CUU } Leucine L CUC } CUA } CUG }	CCU } Proline P CCC } CCA } CCG }	CAU } Histidine H CAC } CAA } Glutamine Q CAG }	CGU } Arginine R CGC } CGA } CGG }		C
	A	AUU } Isoleucine I AUC } AUA } AUG } Methionine start codon M	ACU } Threonine T ACC } ACA } ACG }	AAU } Asparagine N AAC } AAA } Lysine K AAG }	AGU } Serine S AGC } AGA } Arginine R AGG }		A
	G	GUU } Valine V GUC } GUA } GUG }	GCU } Alanine A GCC } GCA } GCG }	GAU } Aspartic acid D GAC } GAA } Glutamic acid E GAG }	GGU } Glycine G GGC } GGA } GGG }		G

This table is from: biogem.org. However, similar versions can be found online for printing.

D: Let it flow

Specialty: Neuropathology

Find out more about this specialty here:

1. [Neuropathology careers page](#)

You'll need to be near a tap, or have some water ready in a glass or jug. Roll a sheet of paper into a wide straw. There's no need to secure it with tape. This is a blood vessel in the brain. Hold the paper straw gently in the middle, and pour water through it. The water is the blood flowing through the vessel. Now pinch your fingers together where you are holding the straw. Water can no longer flow through, i.e. the flow of blood stops. You may also find that the paper straw falls apart and the water flows out from somewhere else.

When there is a blockage (such as fatty substances called plaques) in a blood vessel, this is known as atherosclerosis. This reduces the blood flow to important organs, meaning the oxygen supply decreases. Strokes occur when the blood flow to the brain is blocked. Another type of stroke occurs when the blood vessel breaks and blood leaks into the tissues outside. This is called a haemorrhage. Depending on the area of the brain where a stroke occurs, a patient will have different symptoms. For example, if the area associated with language is affected by the stroke, the patient may have trouble speaking.

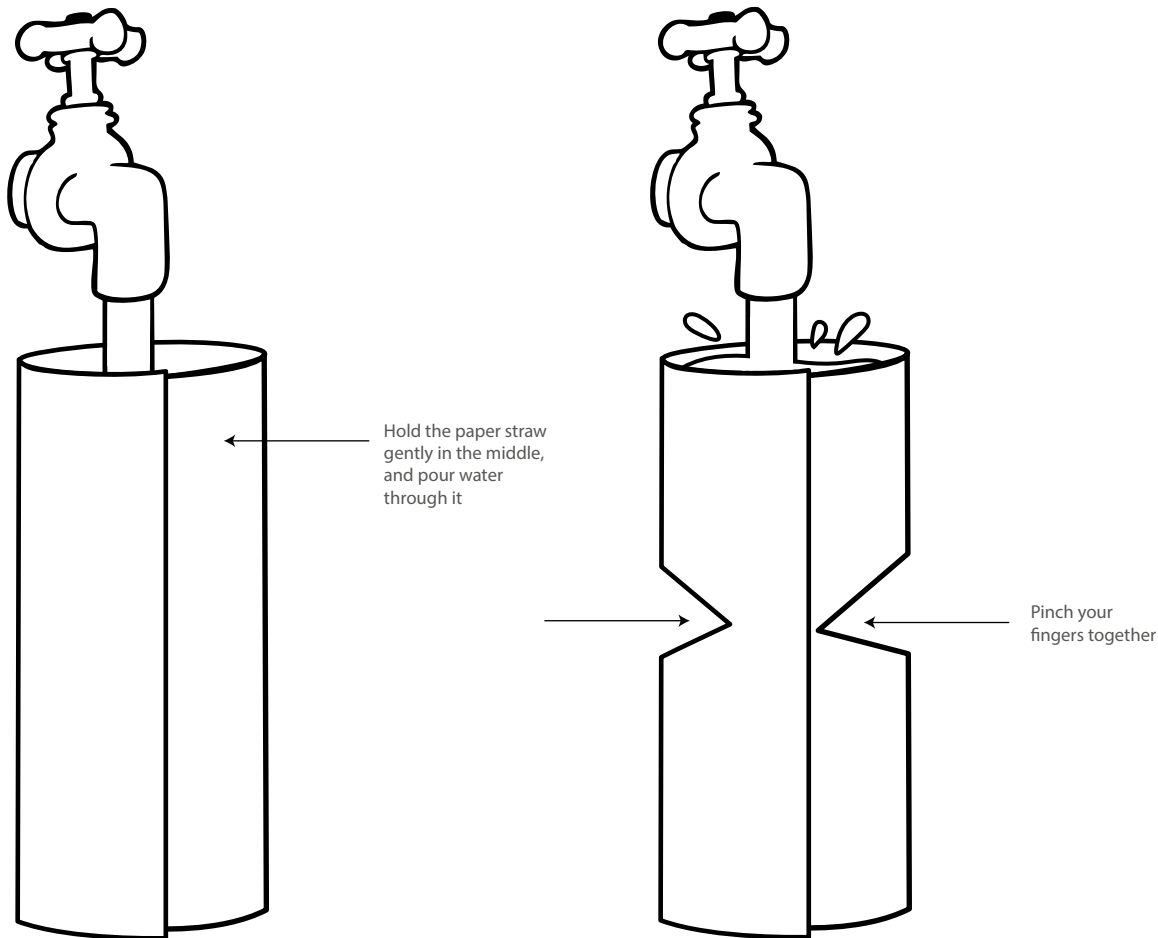

E: Mirror mirror...

Specialty: Paediatric and perinatal pathology, Forensic pathology

Find out more about these specialties here:

1. [Paediatric and perinatal pathology career page](#)
2. [Forensic pathology careers page](#)

When working on paediatric or perinatal cases, i.e. with very young children, small babies or newborns, as well as in forensic cases, there may be a need to use keyhole procedures to diagnose the condition or investigate the cause of death.

But how easy is it to use tools to explore when you can't look directly at what you are investigating?

Place a selection of small items, e.g. a marble, bead, drawing pin, paperclip and business card, in a small box. Using a spoon, fork or chopsticks, can you pick the items up and move them outside of the box ... but without looking directly at the box? Use a mobile phone (filming what's inside the box) and a tablet, laptop or screen to run screen mirroring so that what is shown on the larger screen is what you have to look at. If the technology is temperamental, try using instead a large mirror that reflects what's in the box. Look at the reflection of the box's contents and try using the tools to move the items.

Pathologists need to perfect their hand-eye coordination skills when performing accurate keyhole procedures or when dissecting samples under the microscope.

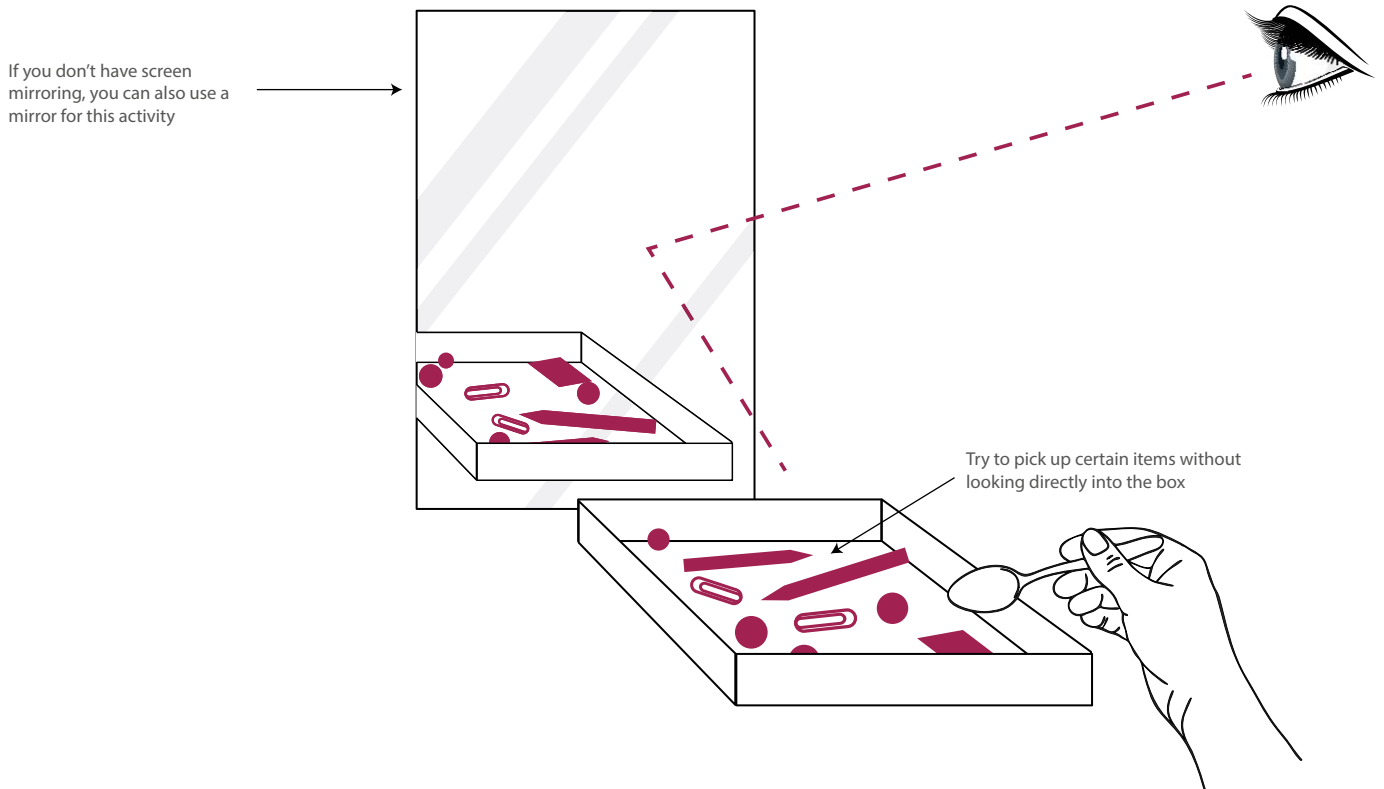

F: Locks of enzymes

Specialty: Clinical biochemistry

Find out more about this specialty here:

1. [Clinical biochemistry careers page](#)

Looking at a selection of keys and padlocks, can you match them up?

The key is the substrate, or molecule, that the enzyme (padlock) will act on. Enzymes will only work on that particular substrate. Once the right substrate (key) fits in the right active site (keyhole) on the enzyme (padlock), the reaction can happen (padlock opens). This is known as the 'Lock and key hypothesis', as described by the German chemist Emil Fischer in 1894.

If you haven't got access to a padlock, but have a variety of keys, try pressing one of the keys into some modelling clay ahead of time to make a mould. Which key fits exactly into that mould?

Enzymes are biological catalysts, speeding up reactions that happen in our bodies.

Some diagnostic tests used by clinical biochemists to analyse our specimens will involve enzymes.

This activity can also be used to demonstrate how antibodies (padlock) and antigens (key) fit together (see 'Everybody's antibodies', page 5).

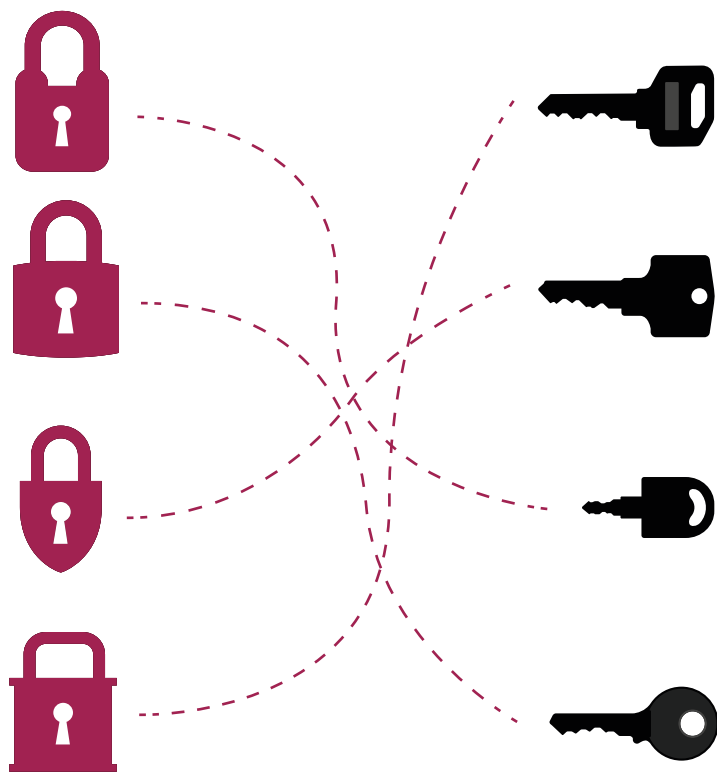

G: The clot thickens

Specialty: Haematology

Find out more about this specialty here:

1. [Haematology careers page](#)

You'll need two glasses or mugs, and one of them must be microwave-safe. Label them Cup 1 and Cup 2 (the microwave-safe one), using a wash-off pen or similar.

Add a little water into both cups, 2-3cm depth is enough. Add a few drops of red food colouring into both and stir well with a teaspoon. Leave Cup 1 as it is, and then into Cup 2 add a teaspoon of cornflour and mix well. Put Cup 2 into the microwave and heat it on high for 30 seconds. When Cup 2 is taken out of the microwave, it will be hot, so leave it on the side to cool for a few minutes.

The contents of the two cups represent blood: Cup 1 shows what our blood looks like when it flows freely through our body, taking oxygen to all our vital organs and removing waste. Cup 2 shows what happens when our blood clots. (If you didn't mix in the cornflour well before it went into the microwave, you should see tiny 'clots').

Whenever our skin becomes broken, blood vessels are damaged, blood is released and the sticky platelets contained in the blood form clots to stop blood flow. As soon as blood from a wound is exposed to the air, the platelets disintegrate and react with fibrinogen to create fibrin, a mass of tiny threads. This triggers a whole series of sequential reactions that rely on adequate levels of calcium and vitamin K to work. This process is known as the 'clotting cascade' (also known as the 'coagulation cascade'). The fibrin hardens very quickly to form a scab, sealing the wound. The wound heals and the clot dissolves. Unless prevented from doing so, blood collected into blood bags undergoes the same process and will clot.

Find more activities about the blood in our [Blood and Bugs](#) resources.

H: Miniscule modelling

Specialty: Microbiology, Virology

Find out more about these specialties here:

1. [Medical microbiology careers page](#)
2. [Virology careers page](#)

Using modelling clay, matchsticks and/or cocktail sticks, can you create a bacteriophage or coronavirus model using the images below as a guideline?

Once you've created your virus model, measure it. If a real SARS-CoV-2 virus particle is 0.1 micrometres in diameter and a T4 bacteriophage is 200 nanometres long, to what scale have you made your model, i.e. how many times bigger than the real thing is your model?

And, if a human cell is 1,000 times bigger than a virus particle, can you measure how big a human cell would be if it was right next to your virus model? Is the human cell bigger than the room you're in?

Note: There are 1,000 micrometres in 1 millimetre, and 1,000 nanometres in 1 micrometre, so there are 1,000,000 nanometres in 1 millimetre.

Viruses come in a variety of shapes and forms. The Coronaviruses are round with spikes. They are called coronaviruses because the word 'corona' means 'crown' or 'wreath' in Latin. The COVID-19 virus, or SARS-CoV-2, is an RNA virus, meaning it contains ribonucleic acid, unlike the T4 bacteriophage, such as Escherichia, which is a DNA virus containing deoxyribonucleic acid. Bacteriophages infect bacteria and reproduce inside them, which is why bacteriophages are so useful in biotechnology research to exchange genetic material. RNA viruses are different from DNA viruses in that they have a high mutation rate, so creating vaccines can be difficult. The COVID-19 virus is an RNA virus and scientists have been able to develop a vaccine by using a small piece of RNA from the virus to instruct cells in the human body to start making viral proteins. The body will then start to make antibodies against these proteins. See activity J to find out about antibodies.

Virus

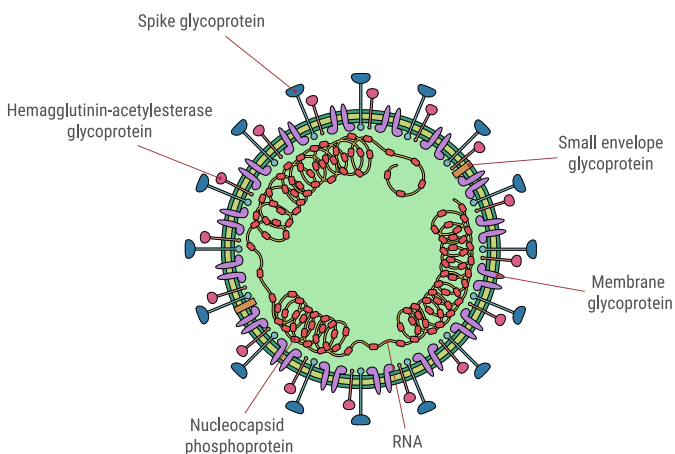

Bacteriophage

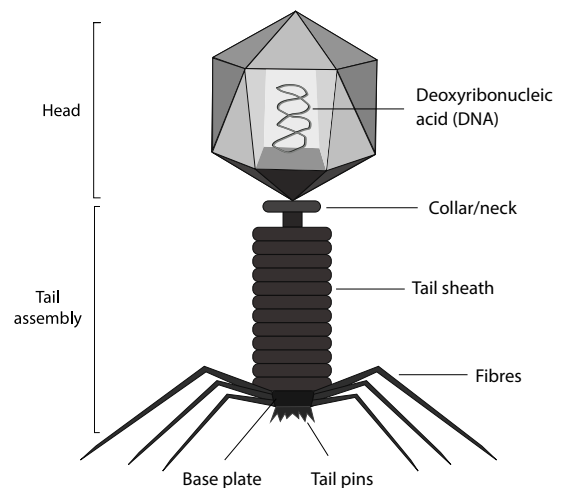

I: Wash your hands

Specialty: Microbiology, Virology

Find out more about these specialties here:

1. [Medical microbiology careers page](#)
2. [Virology careers page](#)

You will need a small saucer with some water in it. Sprinkle some ground pepper onto the surface of the water. While this is a surface tension demonstration, it can be used to highlight the importance of hand-washing.

The pepper grains represent bacteria and viruses capable of causing an infection. If you place a finger into the middle of the pepper grains floating on the water, nothing happens. In fact, a few grains may be stuck to your finger as you remove it. Now add some washing-up liquid to your finger and repeat. All the pepper moves away from your finger.

As long as we wash our hands, especially before eating or touching our faces, and after touching surfaces and items that may have come into contact with infected individuals, we can be sure we won't catch any diseases. Washing our hands with soap removes from our skin oils to which harmful microbes can stick.

Do you wash your hands properly?

Pathologists and other health professionals working in hospitals follow the official hand-washing guidance provided by the NHS.



Hand-washing technique with soap and water

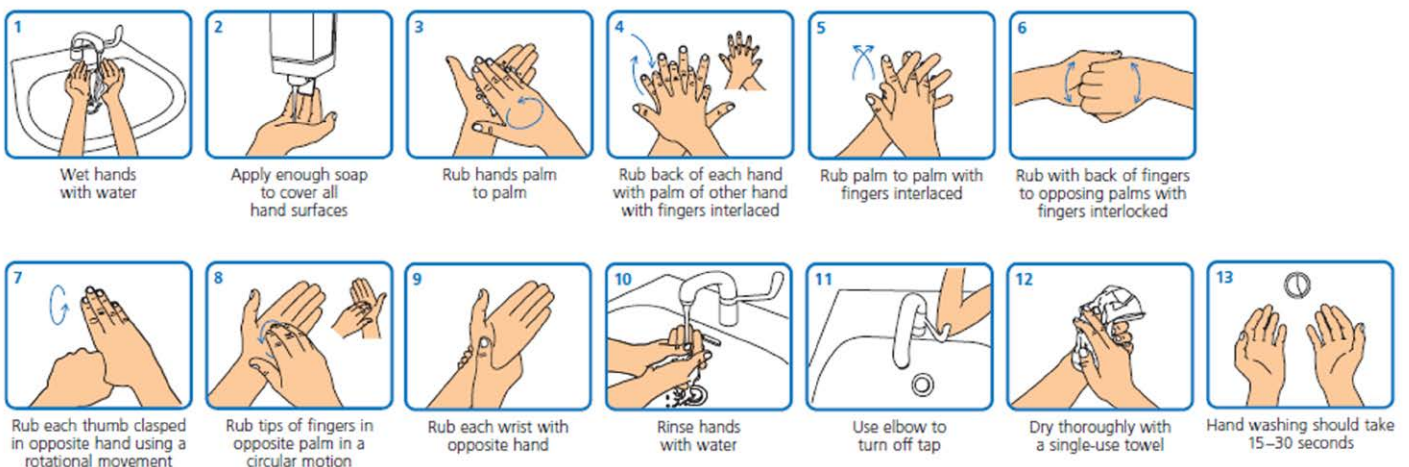

J: The blood group game

Specialty: Haematology, Immunology, Genetics

Find out more about these specialties here:

1. [Haematology careers page](#)
2. [Immunology careers page](#)
3. [Genetics careers page](#)

This activity investigates blood groups using coloured blocks, beads or pieces of card. You will need four colours – green, red, blue and yellow. If you don't have these colours, use whatever four colours you do have. Each colour represents a different blood group – A, B, AB and O. Refer to the 'rules' in this table when playing the game.

Our blood type, known as our 'blood group', depends on the presence of certain 'features', or antigens, on the surface of red blood cells (the cells that carry oxygen around our body). People can have A antigens, B antigens, both or neither on their red blood cells. This affects what blood our bodies will accept if we ever have to have a blood transfusion – you will find out more about this after you've played the game.

Blood group	Antigens on the red blood cell surface	Antibodies in the blood plasma	Can donate blood to	Can receive blood from
AB – green	A and B	None	AB	AB, A, B, O
A – red	A	B	A and AB	A and O
B – blue	B	A	B and AB	B and O
O – yellow	None	A and B	AB, A, B, O	O

[Click here for a printable copy of this table.](#)

How to play the game

Put all the blocks, beads or pieces of card into a bag and give it a shake (if using beads, it would be best to string them together so that you know which bead was added last). Then take one item out randomly, without looking. What blood group does it represent? Place it on the table. If playing in a group, the next person takes out a second item in the same way, and so on. What blood group is the second item? Refer to the rules in the table to place your items (representing a blood donation) correctly onto other items. E.g. if the first item was red, i.e. blood group A, and the second was yellow, i.e. blood group O, then the yellow brick can be stacked on top of the red brick, as someone with blood group O can donate to someone with blood group A. If the second item was blue, i.e. blood group B, because it cannot be donated to someone with blood group A, it cannot be stacked on top of the red item and must be placed to the side.

Continue taking items out and donating blood.

Worked example

If the following order occurred:

1st item: red (blood group A).

2nd item: blue (blood group B) – cannot be stacked on top of the first item, so sits to the side.

3rd item: yellow (blood group O)– can be stacked on either the first or second brick (which then makes this stack a blood group O, and so cannot receive any donated blood other than from another O). You could put this to the side, too, to use when needed, as it is a universal donor.

4th item: green (blood group AB) – cannot be stacked on top of any item because it can only donate to another AB.

The winner is whoever has the tallest stack, or fewest 'single item stacks'.

How does this work in blood transfusion?

The surprising thing is that we make antibodies against the antigens that we are missing, e.g. a person with blood group A has antibodies against B antigens. This becomes a problem in blood transfusion if a person is given blood that doesn't match theirs. For instance, if a person with blood group A is given a transfusion of blood from a person who is blood group B, the pre-formed antibodies attack the red blood cells, and this reaction can be life-threatening. To prevent this, doctors use cross-matching.

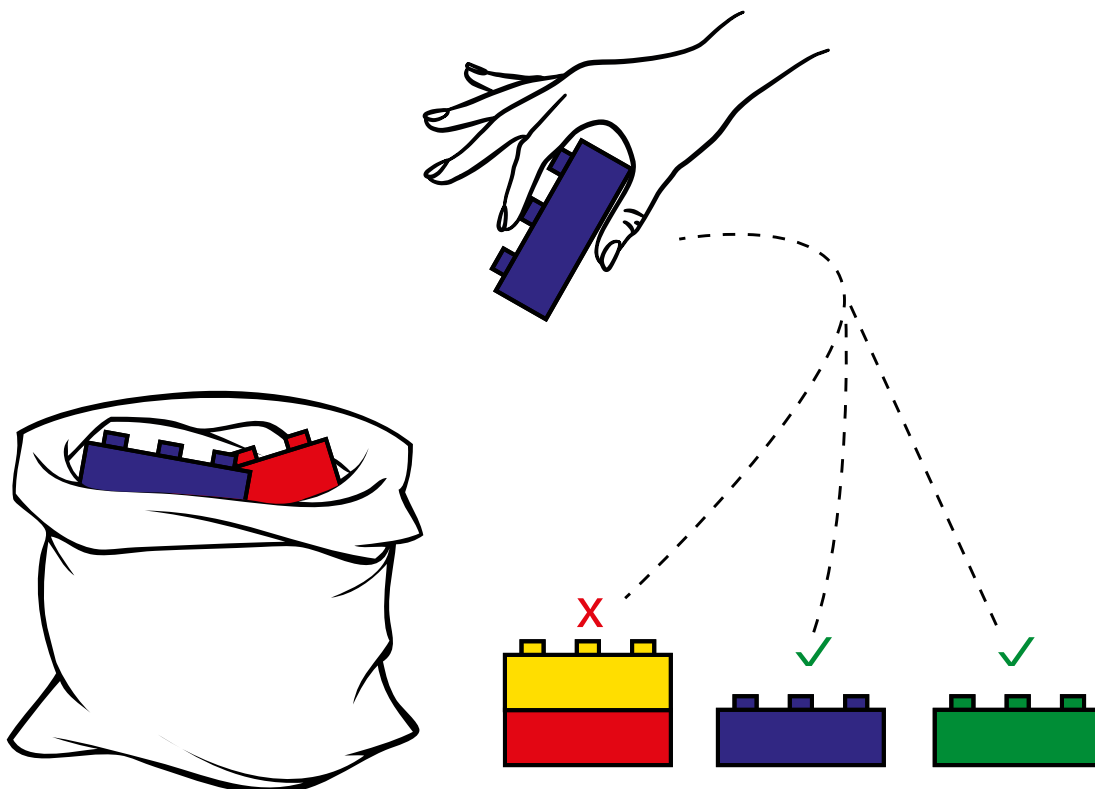

K: Drawn to pathology

Specialty: Depending on what students are asked to draw: Neuropathology, Forensic pathology, Toxicology

Find out more about careers in pathology here:

1. [Pathology careers](#)

Other activities that may be useful:

1. [Organ activity](#)
2. [‘What does your poo say about you?’ activity](#)
3. [Pin the microbe on the human activity – page 18 of ‘Pathology for Life’ pack](#)

Draw a basic outline of the human body on A4 paper with a pen or pencil. The challenge now is to draw the organs inside the body: of the digestive system, nervous system or respiratory system.

Now find a diagram online of the system you’ve drawn. What have you missed out? What have you assumed?

Often we forget just how far the nervous system stretches – all the way to the fingertips. And it’s not always easy to remember every single organ involved in the digestive system or where exactly it is. By looking closely at how the organs are linked (not just through the flow of blood), we notice how toxins can spread throughout the body and affect multiple organs. Toxicologists are interested in knowing more about this.

[Find out more about what it is like to work in toxicology](#)

Here are some organs to get you started ...

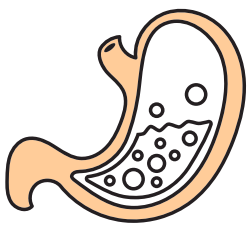

STOMACH

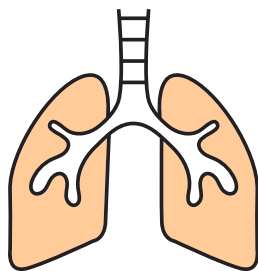

LUNGS

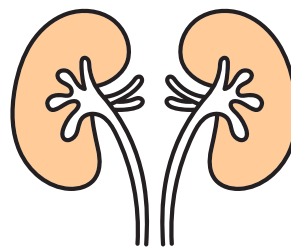

KIDNEYS

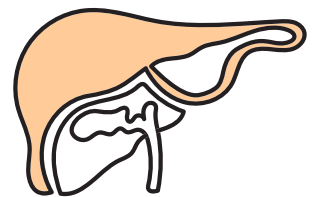

LIVER

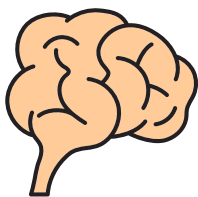

BRAIN

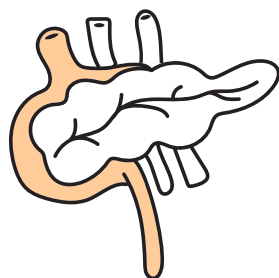

PANCREAS

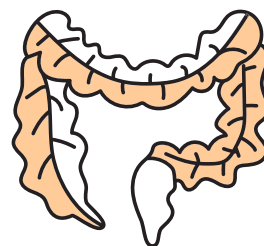

LARGE INTESTINE



HEART

L: And what's more...

Specialty: Various

[Find lots more pathology-themed activities on our website](#)

If you have access to a printer, you can also find materials to download and print off, for example this one on vaccination: [Give it a shot](#)

If you find alternative ways to use the activities provided, closely linking to the pathology specialties, do let us know by emailing us or by getting in touch on social media – see links below.

Follow us on:



[Facebook](#)



[Twitter](#)



[Instagram](#)



Show



Hand out



Fact



Test



Ask/discuss

Blood group	Antigens on the red blood cell surface	Antibodies in the blood plasma	Can donate blood to	Can receive blood from
AB	A and B	None	AB	AB, A, B, O
A	A	B	A and AB	A and O
B	B	A	B and AB	B and O
O	None	A and B	AB, A, B, O	O